

DANCOVER[®] 

Party tent
6 m PVC Series

DANCOVER[®]

.com

Safety Advice

Attention

In some countries approval is needed to set up a marquee/tent larger than 75 m². It is your responsibility to comply with local rules and regulations and to ensure that the marquee/tent is assembled correctly.

In case of bad weather conditions, it is your responsibility to ensure the marquee/tent is safely secured and that the marquee/tent does not cause damage to others.

Do not use open fire, welding equipment or other sources which can ignite, inside or close to the tent.

The marquee/tent must be safely secured. We recommend you secure your marquee/tent with straps and pegs as soon as it is assembled.

Make sure to check if the marquee/tent is covered by your home contents insurance.

Marquees/tents must be evacuated under extreme weather conditions.

In the event of snow always remove snow from the roof of the marquee/tent regularly to prevent snow from building on the roof as heavy snow can cause the marquee/tent to collapse.

In the event of rain there is a risk of rain puddles building up on top of the roof of the marquee/tent. Heavy rain puddles can cause the roof to collapse. It is your responsibility to ensure rain puddles do not build up. As a precaution, make sure the roof of the marquee/tent is stretched out properly and adequately over the side frames of the marquee/tent and remove rain water regularly.

Do not unpack or repack your marquee/tent in freezing temperatures. In case of temperatures below zero always unpack and repack your marquee/tent indoors to avoid the risk of cracking parts.

The marquee/tent must be totally dry before you repack and store it to avoid mildew.









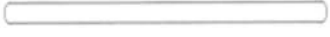

Note: Marquees are intended for events and other arrangements and are as such only meant for short term temporary assembly and the following disassembly. Dancover warranty applies only to the normal use of the Product, normal wear and tear excepted, in accordance with written use instructions or manual. The warranty does not apply to damage caused by accident, abuse, misuse, or modification of the Product.

Warranty Information

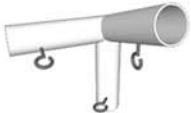



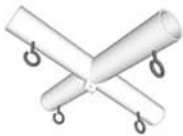

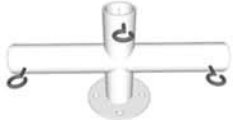





Please visit dancovershop.com for information on warranty.

Please always check our website for the latest safety advice and manual.

Part list.

Part No.	Part	6m	8m	10m	12m	14m
No. 01	 1470mm	16 PCS	20 PCS	24 PCS	28 PCS	32 PCS
No. 02	 1940mm	27 PCS	34 PCS	41 PCS	48 PCS	55 PCS
No. 03		8 PCS	10 PCS	12 PCS	14 PCS	16 PCS
No. 04	 1940mm	8 PCS	10 PCS	12 PCS	14 PCS	16 PCS
No. 05	 1470mm	4 PCS	5 PCS	6 PCS	7 PCS	8 PCS
No. 06	 1470mm	4 PCS	4 PCS	4 PCS	4 PCS	4 PCS
No. 07	 1470mm	4 PCS	6 PCS	8 PCS	10 PCS	12 PCS
No. 08	 1470mm	2 PCS	2 PCS	2 PCS	2 PCS	2 PCS
No. 09	 1470mm	2 PCS	3 PCS	4 PCS	5 PCS	6 PCS
No. 10	 1470mm	4 PCS	6 PCS	8 PCS	10 PCS	12 PCS
No. 11	 1470mm	4 PCS	4 PCS	4 PCS	4 PCS	4 PCS
No. 12	 1470mm	4 PCS	4 PCS	4 PCS	4 PCS	4 PCS
No. 13	 1470mm	4 PCS	6 PCS	8 PCS	10 PCS	12 PCS

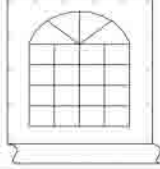
Part list.

Part No.	Part	6m	8m	10m	12m	14m
No. 14		4 PCS	4 PCS	4 PCS	4 PCS	4 PCS
No. 15		4 PCS	4 PCS	4 PCS	4 PCS	4 PCS
No. 16		8 PCS	10 PCS	12 PCS	14 PCS	16 PCS
No. 17		36 PCS	42 PCS	48 PCS	54 PCS	60 PCS
No. 18		122 PCS	152 PCS	182 PCS	212 PCS	242 PCS
No. 19		16 PCS	20 PCS	24 PCS	28 PCS	32 PCS
No. 20		112PCS	132PCS	152 PCS	172PCS	192 PCS
No. 21		26 PCS	26 PCS	26 PCS	26 PCS	26 PCS
No. 22		4 PCS	4 PCS	4 PCS	4 PCS	4 PCS
No. 24		1 PCS	1 PCS	1 PCS	1 PCS	1 PCS
No. 25		6 PCS	8 PCS	10 PCS	12 PCS	14 PCS
No. 26		1 PCS	1 PCS	1 PCS	1 PCS	1 PCS
No. 27		1 PCS	1 PCS	1 PCS	1 PCS	1 PCS

Assembly

Step 1: Lay out all roof tubes and connectors as shown.

Step 2: Join the roof tubes and connectors from middle and out.

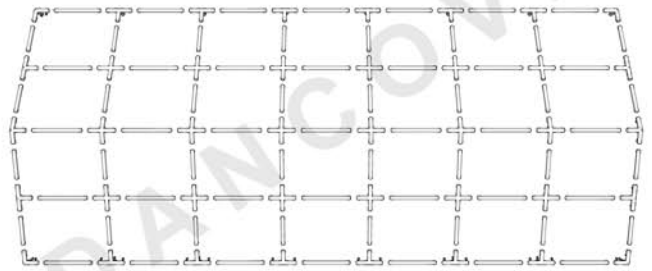

Step 3: Apply the gable safety bars as shown.

Step 4: Make sure all screws are tightened.

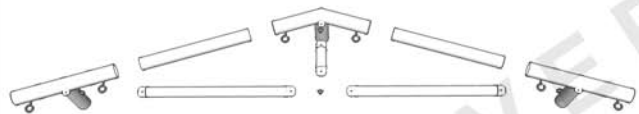

Step 5: Apply legs in one side as shown.

Step 6: Put the roof cover on and tie down with bungeeballs as shown.

* Note, tie in the bungee-balls 5 at one side followed by 5 in the other and continue until finished

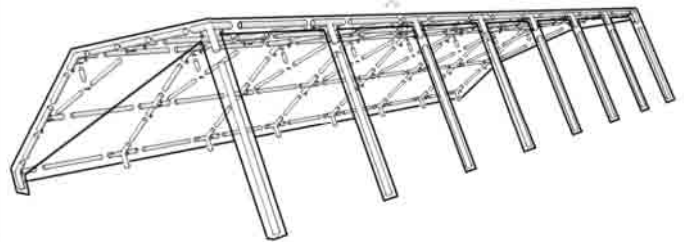

Step 7: Raise the legs in the opposite site.

Step 8: Make sure the cover is fastened.

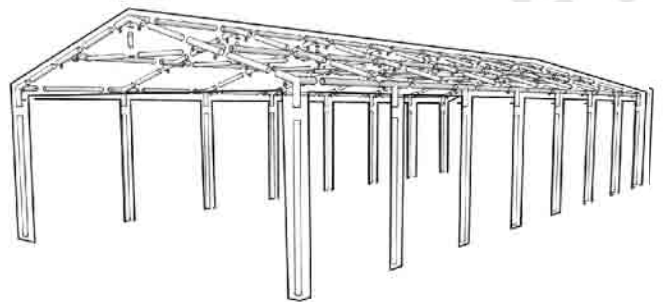

Step 9: Lay out the connectors and tubes of the Ground Bar.

Step 10: Assemble Ground Bar as shown.

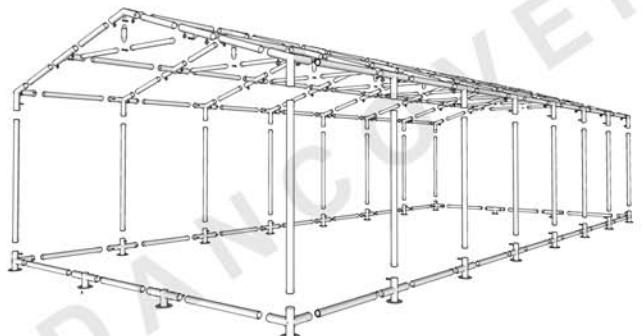

Assembly

Step 11: Attach sidewalls with Bungee balls as shown.

Step 12: Connect leg cover with sidewall and endwall by velcro as shown

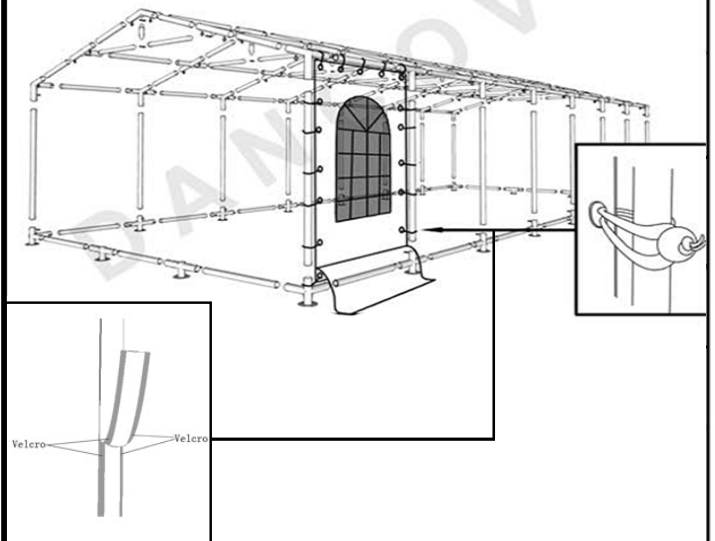

Step 13: Attach endwalls with Bungee balls as shown.

Step 14: Connect leg cover with sidewall and endwall by velcro as shown

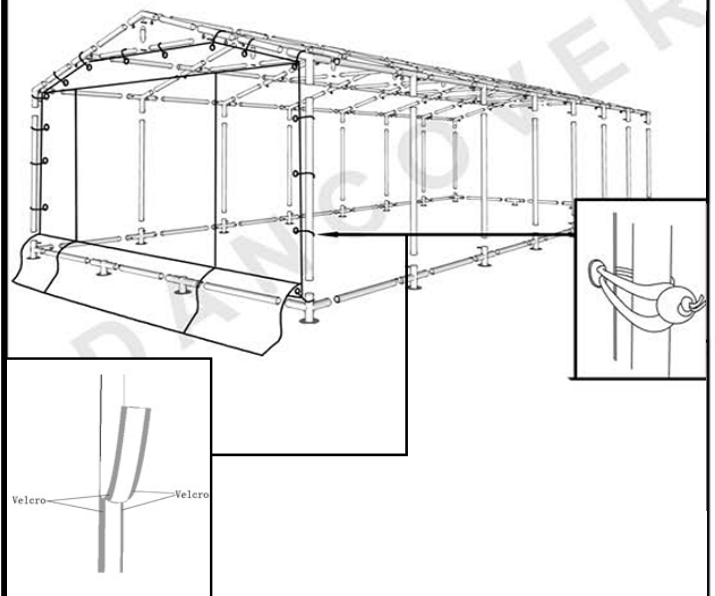

Roof Assembly

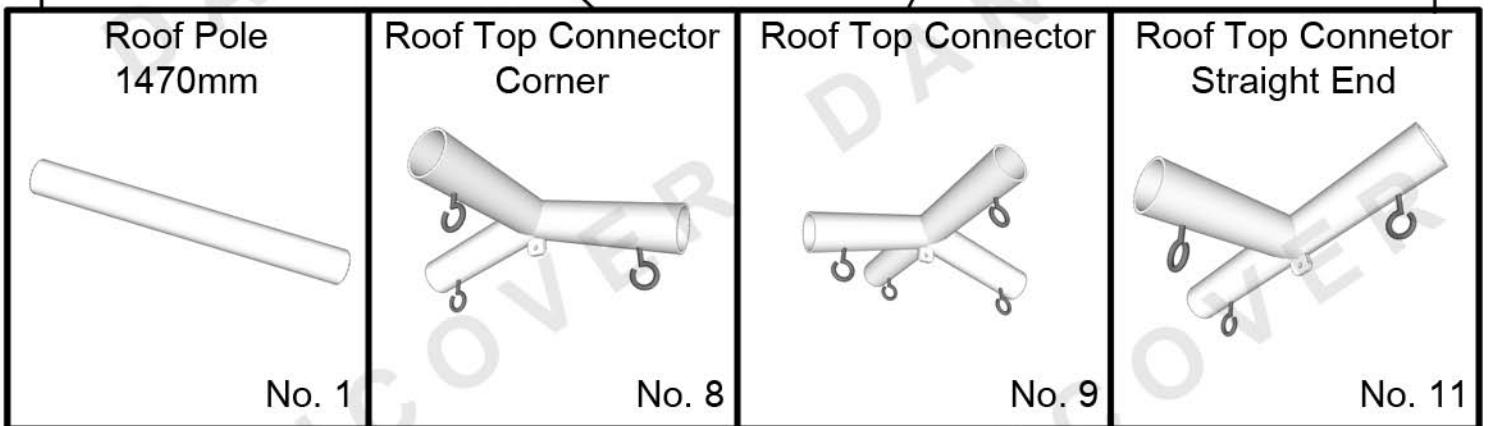
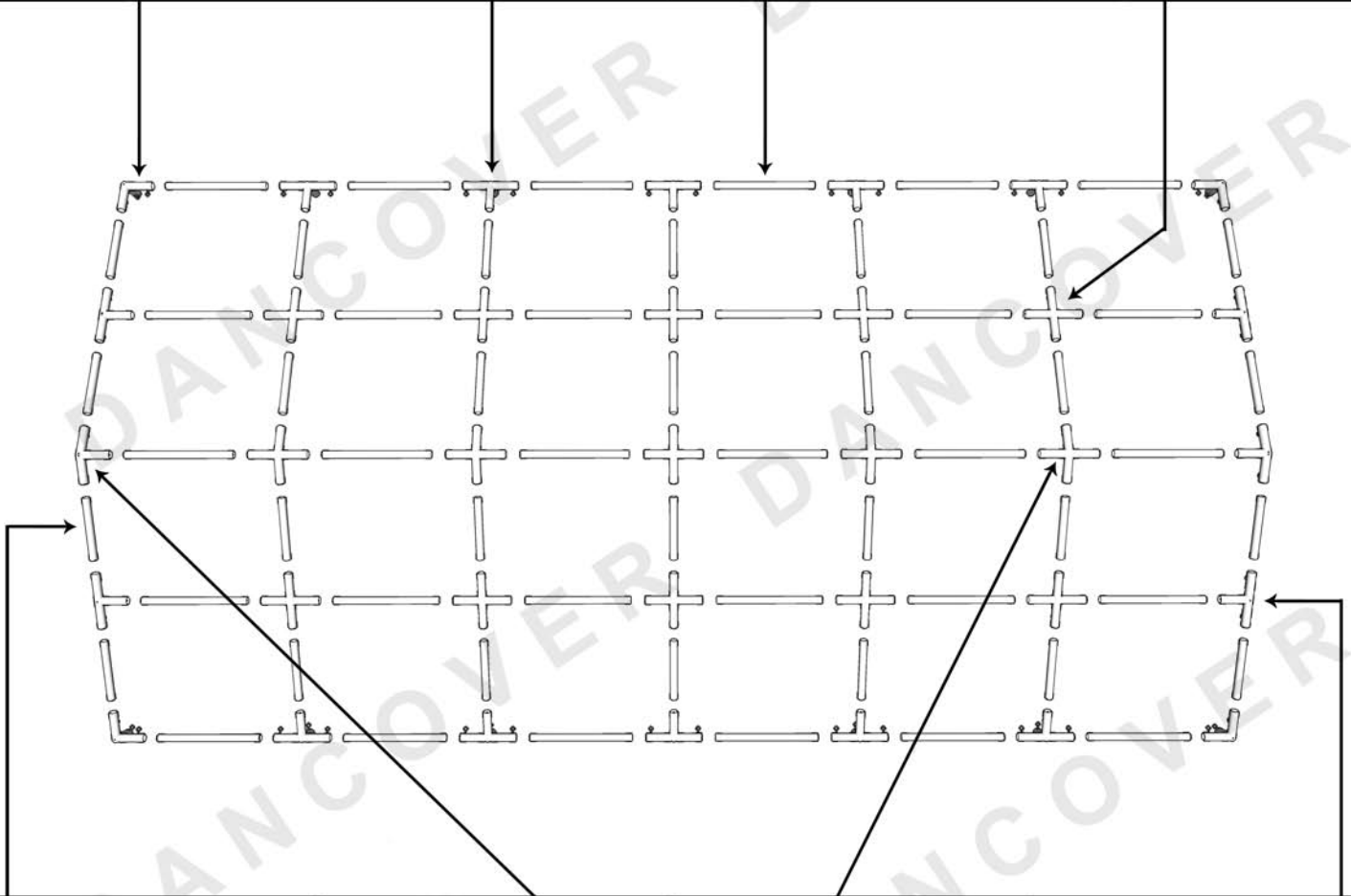
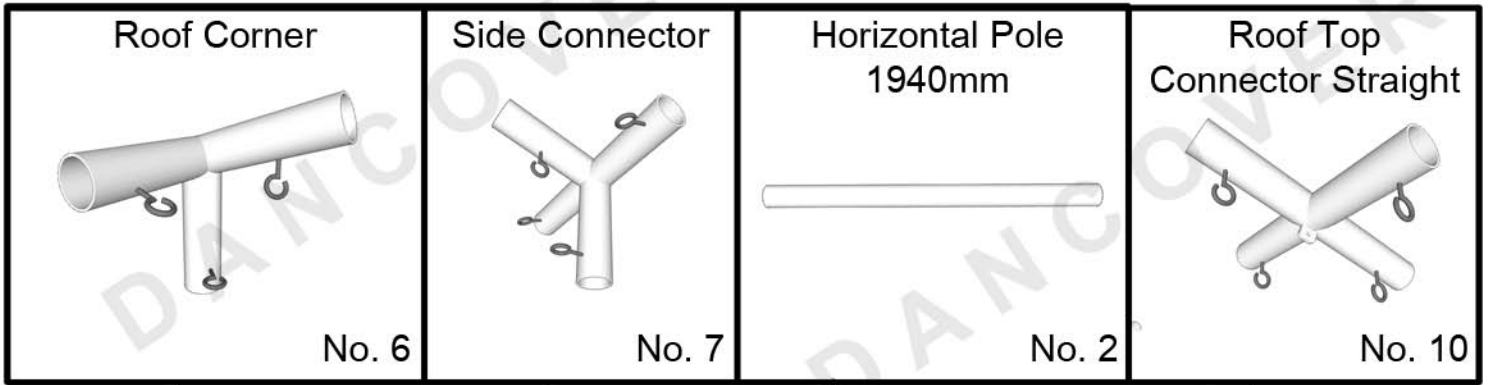

Step 1: Lay out all roof tubes and connectors as shown above.

Step 2: Join the roof tubes and connectors from middle and out.

DANCOVER®

Gable Assembly

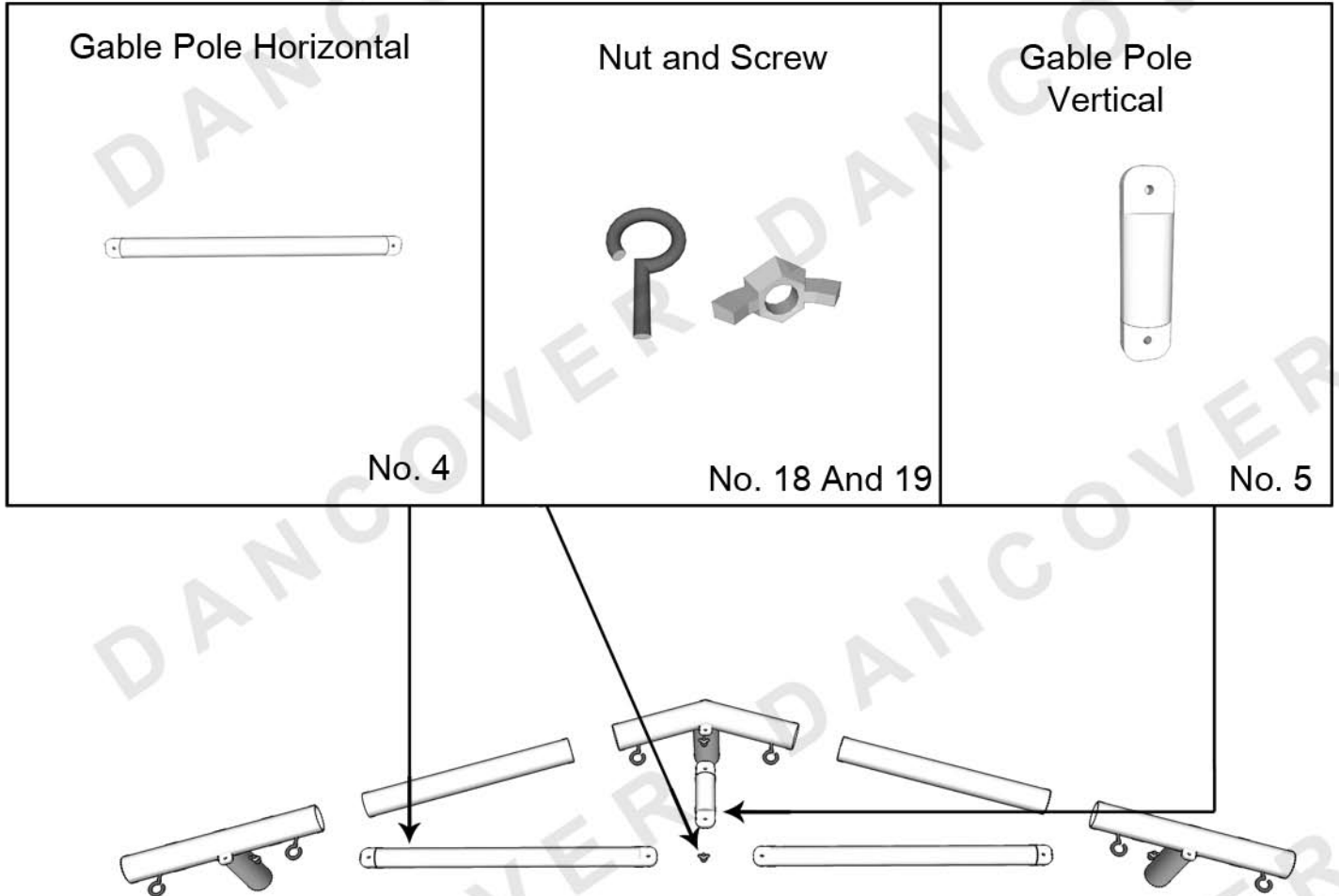

Step 3: Apply the gable safety bars as shown above.
Step 4: Make sure all screws are tightened.

Ground Bar Assembly

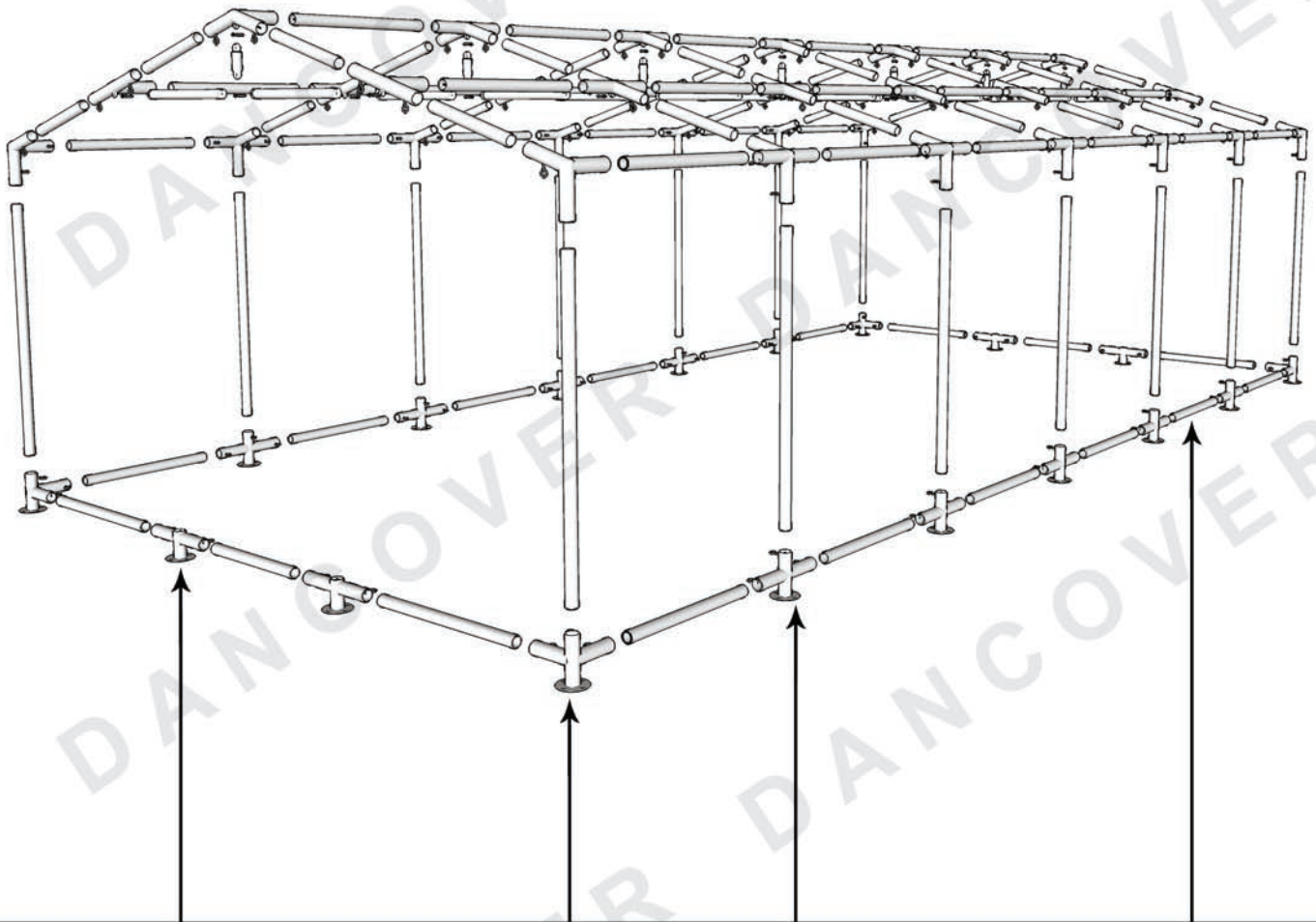

Ground Bar
Connector End



No. 14

Ground Bar
Connector Corner



No. 12

Ground Bar
Connector Side



No. 13

Horizontal Pole
1940mm



No. 2

Step 9: Lay out the connectors and tubes of the ground bar.

Step 10: Assemble ground bar as shown above.

Contact information

Head office:

Dancover A/S
Nordre Strandvej 119 G
3150 Hellebæk
Denmark

For more information
please visit:
www.dancovershop.com

National contact

Denmark:
denmark@dancover.com

UK:
uk@dancover.com

Germany:
germany@dancover.com

France:
france@dancover.com

Sweden:
sverige@dancover.com

Finland:
suomi@dancover.com

Poland:
polska@dancover.com

Luxembourg:
luxembourg@dancover.com

Spain:
espana@dancover.com

Italy:
italia@dancover.com

Switzerland:
schweiz@dancover.com

Austria:
austria@dancover.com

Norway:
norge@dancover.com

Nederland:
nederland@dancover.com

Ireland:
ireland@dancover.com

Belgium:
belgique@dancover.com